

PNP High Power Bipolar Transistor

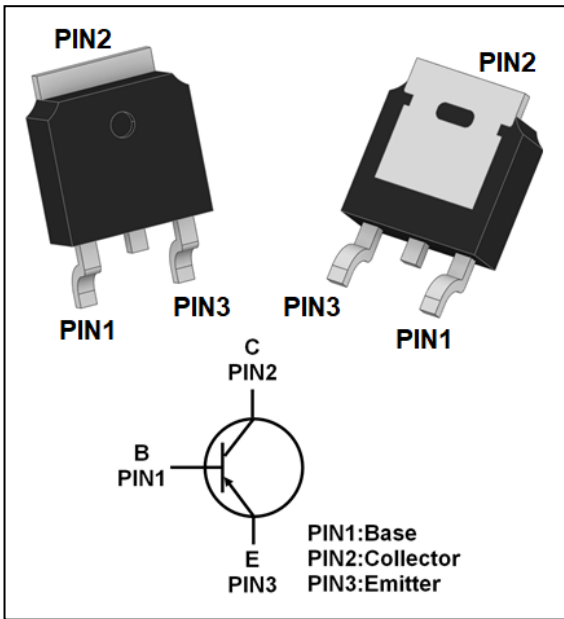

Features

- Epoxy meets UL-94 V-0 flammability rating and halogen free
- Moisture Sensitivity Level 1

Applications

- Complement to 2SC4135
- Low Collector Emitter Saturation Voltage
- Fast Switching Speeds

Mechanical Data

- Package: TO-252
- Terminals: Tin plated leads, solderable per J-STD-002 and JESD22-B102
- Unit Weight: 0.32g

■ Maximum Ratings (Ta=25°C unless otherwise noted)

Item	Symbol	Unit	Value
Device marking code			2SA1593
Collector-base voltage	V_{CBO}	V	-120
Collector-emitter voltage	V_{CEO}	V	-100
Emitter-base voltage	V_{EBO}	V	-6
Collector current	I_c	A	-2
Power dissipation (*)	P_D	W	1.0
Thermal resistance, junction-to-ambient (*)	R_{thJA}	°C/W	125
Junction temperature	T_j	°C	-55 to +150
Storage temperature	T_{STG}	°C	-55 to +150

(*) Device mounted on FR-4 PCB(25.4*25.4*1.0mm)mounting pad.



■ Electrical Characteristics (Ta=25°C unless otherwise noted)

Item	Symbol	Unit	Conditions	Min	Typ	Max
Collector-base breakdown voltage	$V_{(BR)CBO}$	V	$I_C = -100\mu A, I_E = 0$	-120		
Collector-emitter breakdown voltage	$V_{(BR)CEO}$	V	$I_C = -1mA, I_B = 0$	-100		
Emitter-base breakdown voltage	$V_{(BR)EBO}$	V	$I_E = -100\mu A, I_C = 0$	-6		
Collector-base cut-off current	I_{CBO}	nA	$V_{CB} = -100V$			-100
Emitter-base cut-off current	I_{EBO}	nA	$V_{EB} = -4V$			-100
DC current gain	h_{FE}		$V_{CE} = -5V, I_C = -0.1A$	200		400
			$V_{CE} = -2V, I_C = -0.5A$	130		340
Collector-emitter saturation voltage	$V_{CE(sat)}$	V	$I_C = -1A, I_B = -0.1A$			-0.6
Base-Emitter Saturation Voltage	$V_{BE(sat)}$	V	$I_C = -1A, I_B = -0.1A$			-1.2
Collector-base output capacitance	Cob	pF	$V_{CB} = -10V, f = 1MHz$		24	
Transition frequency	fr	MHz	$V_{CE} = -10V, I_C = -250mA, f = 10MHz$	3		

■ Ordering Information (Example)

PREFERRED P/N	PACKING CODE	MINIMUM PACKAGE(pcs)	INNER BOX QUANTITY(pcs)	OUTER CARTON QUANTITY(pcs)	DELIVERY MODE
2SA1593	F1	2500	2500	25000	13"Reel

■ Characteristics(Typical)

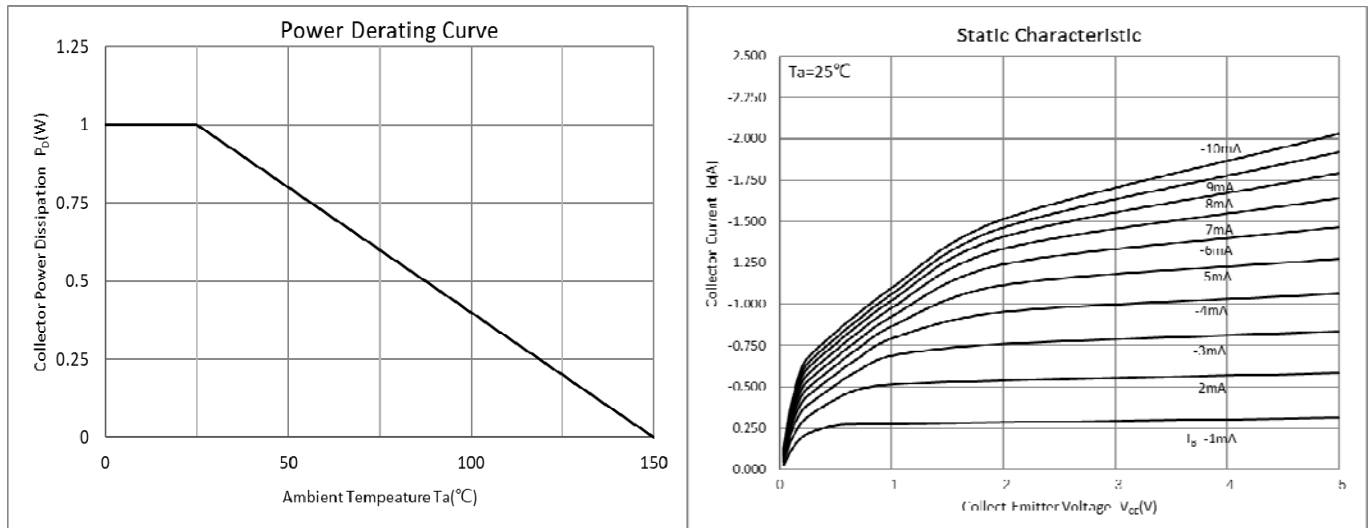



■ Characteristics(Typical)

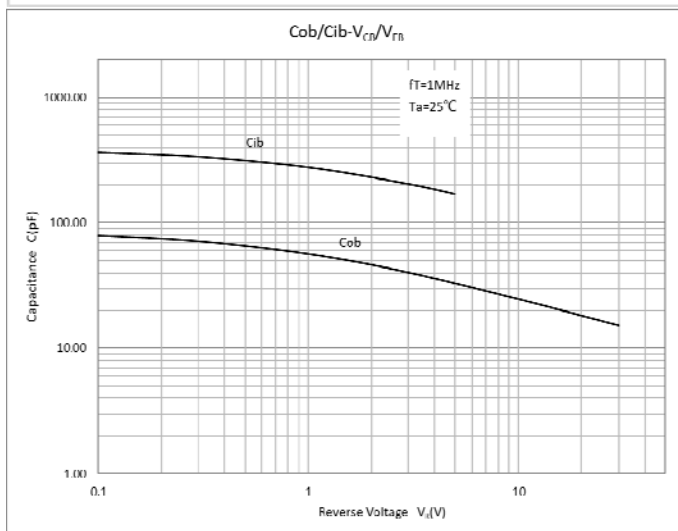
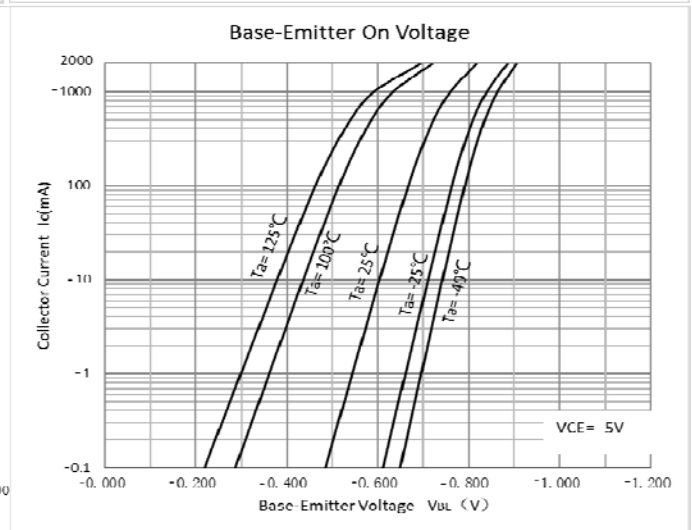
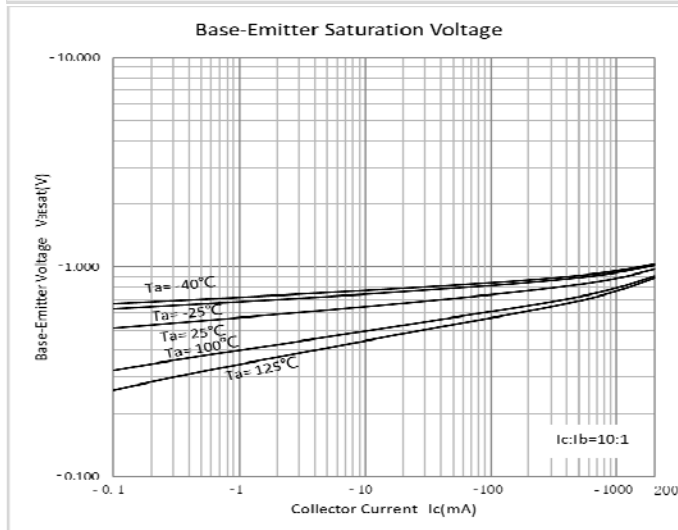
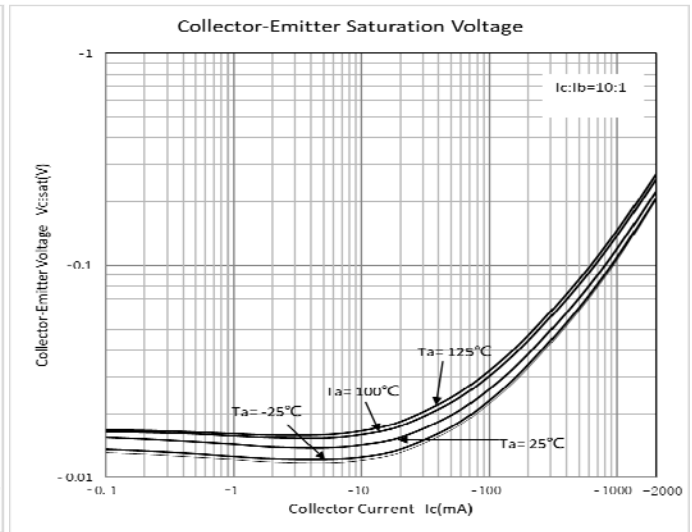
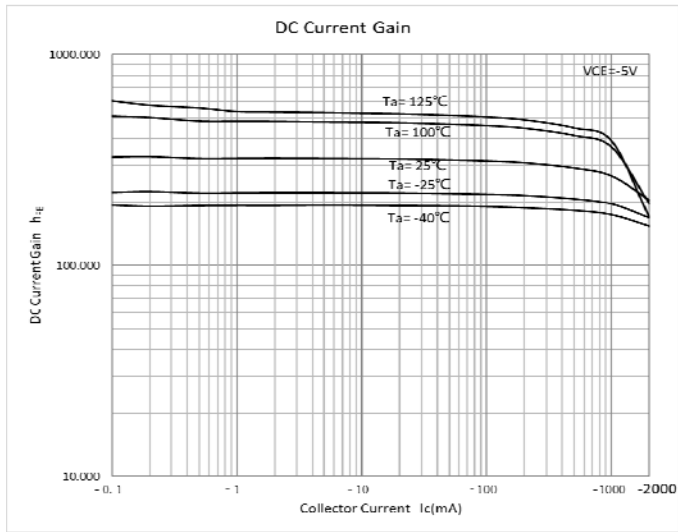

TO-252 Package information

TO-252

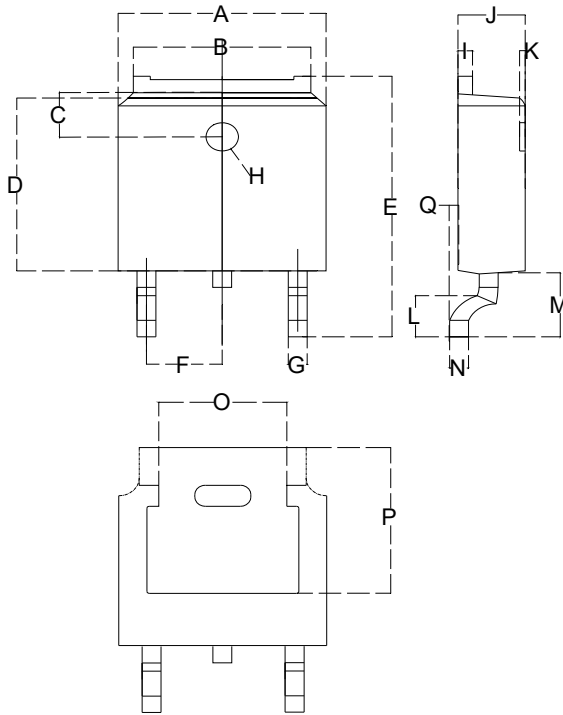

Dimensions in millimeters

TO-252		
Dim	Min	Max
A	6.500	6.700
B	5.100	5.460
C	1.400	1.800
D	6.000	6.200
E	10.000	10.400
F	2.166	2.366
G	0.660	0.860
H	Φ 1.050	Φ 1.350
I	0.460	0.580
J	2.200	2.400
K	0	0.300
L	0.890	2.290
M	2.730	3.080
N	0.430	0.580
O	4.20	4.95
P	5.15	5.45
Q	0	0.2

Suggested Pad Layout

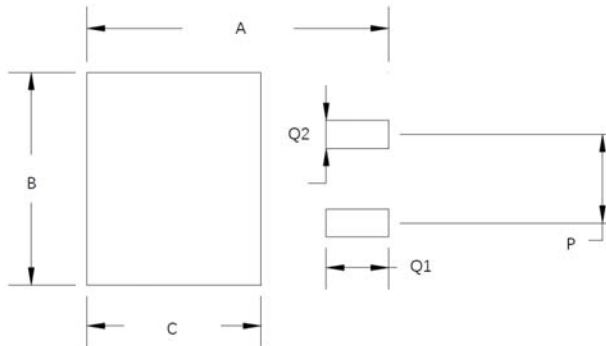

Dim	Millimeters
A	11.4
B	6.74
C	6.23
P	4.56
Q1	2.28
Q2	1.52

Marking Code

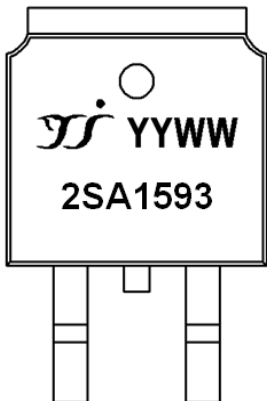

Yangjie LOGO

YYWW: YY, years; WW, week.

For example, 24 represents 2024; 01 represents the first week of this year.

2SA1593: Product model.



Disclaimer

The information presented in this document is for reference only. Yangzhou Yangjie Electronic Technology Co., Ltd. reserves the right to make changes without notice for the specification of the products displayed herein to improve reliability, function or design or otherwise.

The product listed herein is designed to be used with automotive electronics, are not designed for use in medical, life-saving, lifesustaining, or military, Yangjie or anyone on its behalf, assumes no responsibility or liability for any damages resulting from such improper use of sale.

This publication supersedes & replaces all information previously supplied. For additional information, please visit our website [http:// www.21yangjie.com](http://www.21yangjie.com) , or consult your nearest Yangjie's sales office for further assistance.